

Alubin de México

L I N E A N A C I O N A L

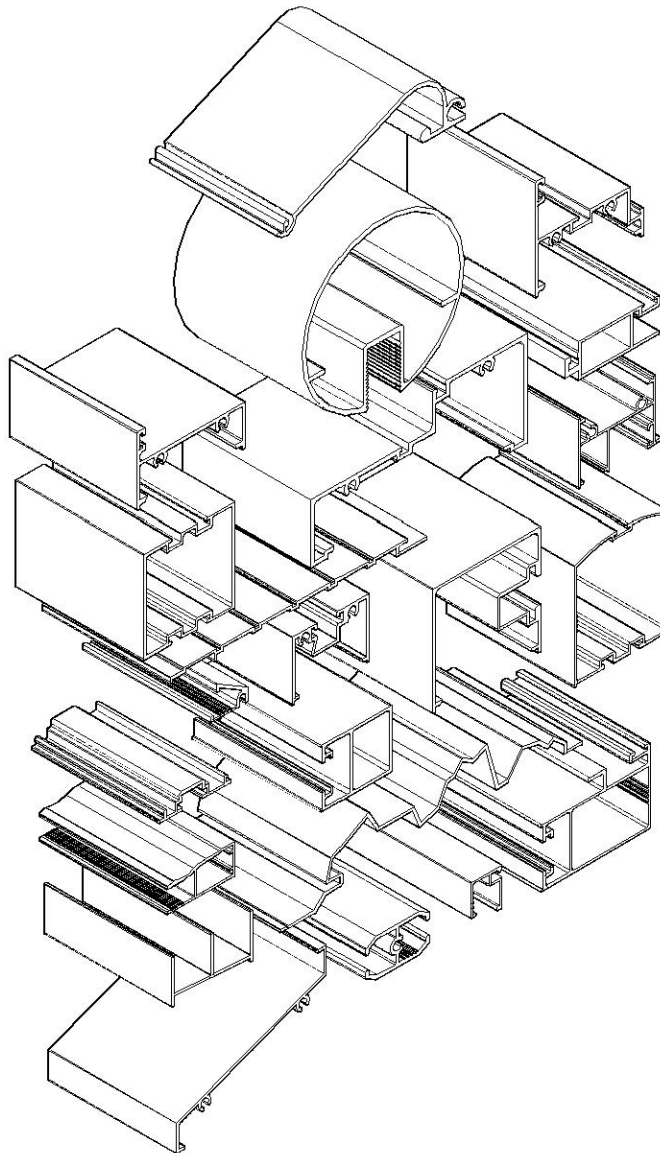



















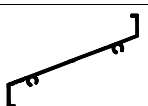
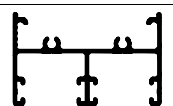





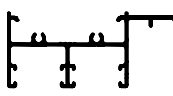

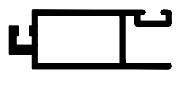
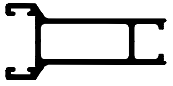

Catálogo

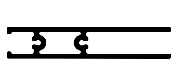
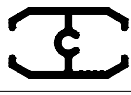
Perfiles Línea Nacional

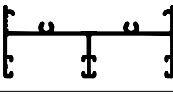

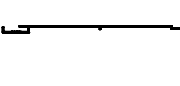
Alubin de México

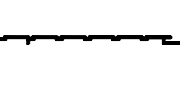
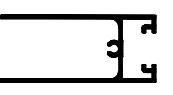
INDICE LINEA NACIONAL

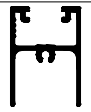
Dibujo	Clave	Pag.	Dibujo	Clave	Pag.	Dibujo	Clave	Pag.
	14	31		4105	17		7315 / L7315	4
	1202	31		4127	21		7316	4
	1308	31		5844 / L5844	17		7333	12
	1314	31		6053 / L6053	27		7518 / L7518	9
	1320	31		6370	17		7818	9
	1329	31		L6371	17		7819 / L7819	10
	1613	31		6533	12		7821 / L7821	9
	L2351	30		6534	12		7822	9
	2415	11		6606	6		7825 / L7825	9
	2416	11		6609	6		7826 / L7826	12
	L2500	30		6617 / L6617	24		7828	12
	2520	30		L6775	24		7835 / L7835	12
	4051	2		7102	21		7836 / L7836	13

Alubin de México

INDICE LINEA NACIONAL

Dibujo	Clave	Pag.	Dibujo	Clave	Pag.	Dibujo	Clave	Pag.
	7842 L7842	13		8591 L8591	2		9088	3
	7843	13		8635	27		9112	4
	7844	13		8936	19		9114 L9114	4
	7847 L7847	13		8937	19		9115	4
	7848 L7848	13		8939	19		9117	6
	7850 L7850	14		9073	1		9118	6
	7862 L7862	14		9074	1		9135 L9135	5
	8320	9		9075	1		9136 L9136	5
	8327	18		9082 L9082	15		9183 L9183	17
	8370 L8370	10		9083 L9083	2		L9184	18
	8380	24		9084 L9084	2		9187 L9187	18
	8550 L8550	16		9085 L9085	2		9204 L9204	18
	8586	2		9086	3		9207 L9207	18











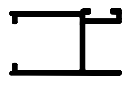

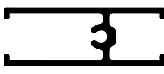
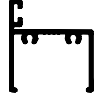

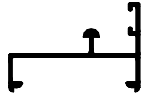
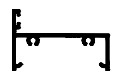

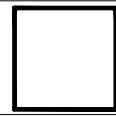

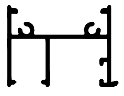

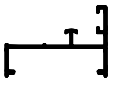
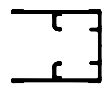
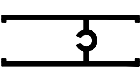
Alubin de México

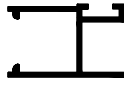
INDICE LINEA NACIONAL

Dibujo	Clave	Pag.	Dibujo	Clave	Pag.	Dibujo	Clave	Pag.
	9236 L9236	15		10056	29		11031	31
	9272 L9272	14		10143	27		11032	16 18
	9525	21		10197	22		11033	31
	9756 L9756	21		10198	22		11035	22
	L9945	21		L10220	15		L11067	30
	9947	21		10235	5		L11084	30
	9953 L9953	10		10236	5		L11086	30
	9954 L9954	10		10237	5		L11093	30
	9955 L9955	10		L10358	15		L11099	30
	9956 L9956	10		10465	20		L11121	30
	9957 L9957	15		10466	20		L11122	30
	10054	25		10467	20		11122	30
	10055	25		10481	6		11124	31

Alubin de México

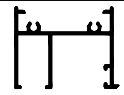
INDICE LINEA NACIONAL

Dibujo	Clave	Pag.	Dibujo	Clave	Pag.	Dibujo	Clave	Pag.
	11128 L81581	24		11836	7		23883	25
	11131	28		11837	7		33087	16
	L11154	30		11838	7		L35844	17
	11154	30		15001	31			
	11156	30		15003	31			
	L11161	30		15309	7			
	11173	22		15310	8			
	11174	22		15311	8			
	L11203	11		15312	8			
	11386	23		15313	8			
	11387	22		15314	8			
	11763	7		20293	26			
	11835	7		22242	30			

Alubin de México

FIJADOR DE 1 1/2"

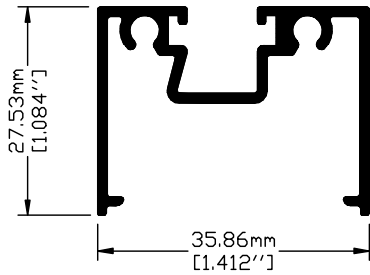

Clave: 9073
Bolsa
Perimetro Anodizable: 25.98 cm

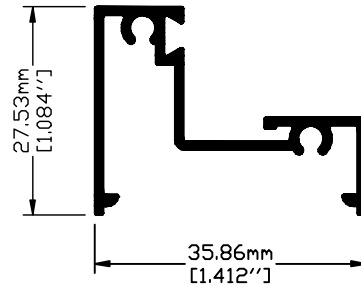

Clave: 9074
Escalonado
Perimetro Anodizable: 22.66 cm

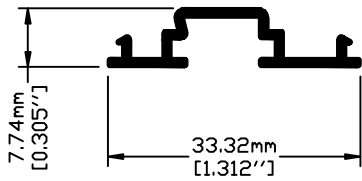

Clave: 9075
Tapa Bolsa
Perimetro Anodizable: 11.54 cm

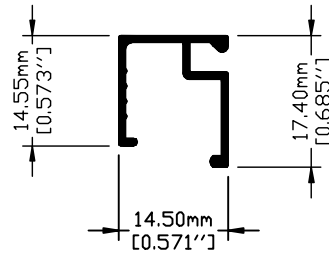

Clave: 6370
Junquillo
Perimetro Anodizable: 10.84 cm

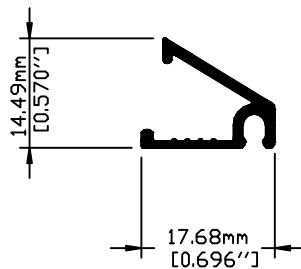

Clave: L6371
Junquillo Biselado
Perimetro Anodizable: 08.81 cm

Alubin de México

FIJO DE 2"

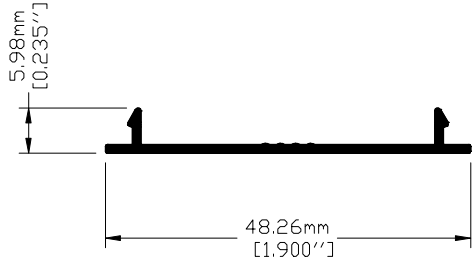

Clave: 4051
Tapa Lisa
Perimetro Anodizable: 11.83 cm

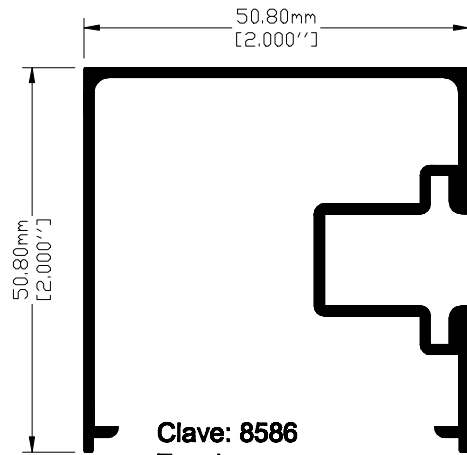

Clave: 8586
Esquinero
Perimetro Anodizable: 40.56 cm

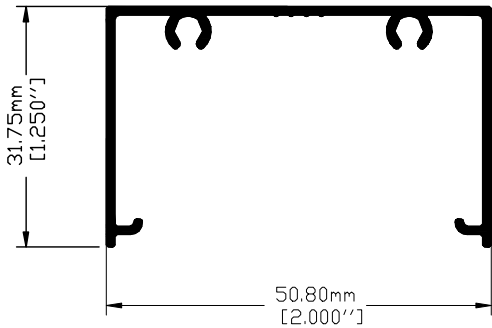

Clave: 8591 / L8591
Bolsa Lisa
Perimetro Anodizable: 27.39 cm

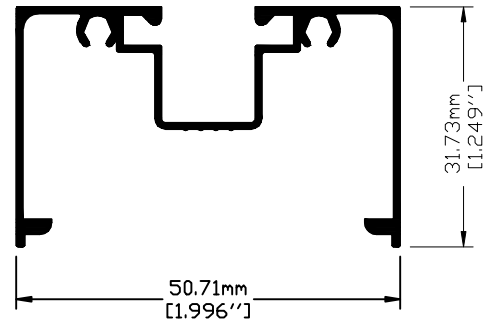

Clave: 9083 / L9083
Bolsa
Perimetro Anodizable: 33.85 cm

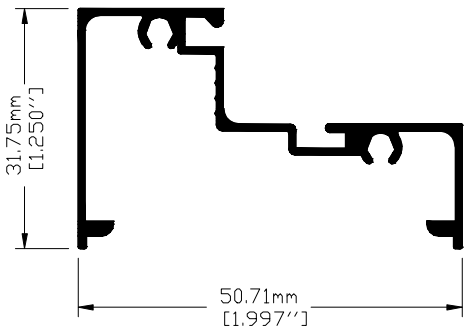

Clave: 9084 / L9084
Escalonado
Perimetro Anodizable: 28.46 cm

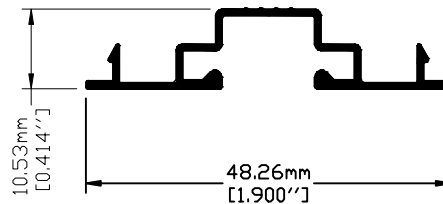

Clave: 9085 / L9085
Tapa Bolsa
Perimetro Anodizable: 17.75 cm

Alubin de México

FIJO DE 2"

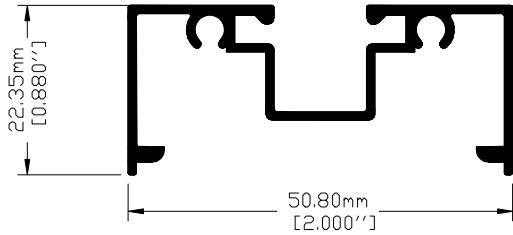

Clave: 9086
Bolsa Corta
Perimetro Anodizable: 29.7 cm

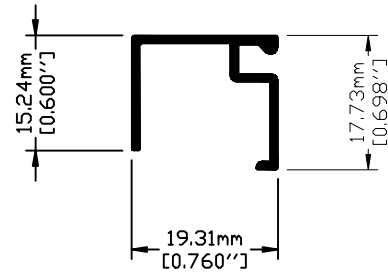

Clave: 9088
Junquillo
Perimetro Anodizable: 11.58 cm

Alubin de México

FIJO DE 3"

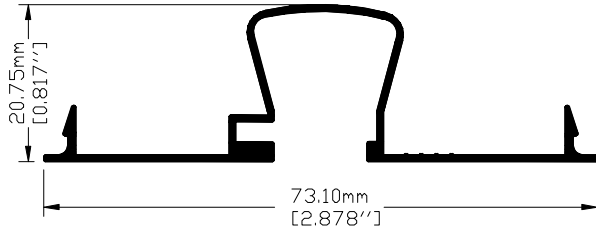

Clave: 7315 / L7315
Tapa Bolsa
Perimetro Anodizable: 26.93 cm

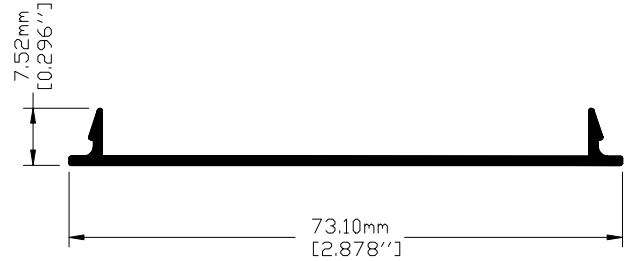

Clave: 7316
Tapa Lisa
Perimetro Anodizable: 17.25 cm

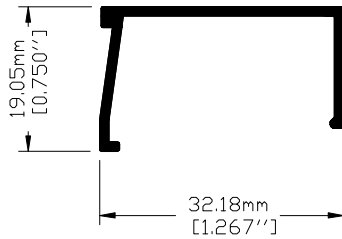

Clave: 9112
Junquillo
Perimetro Anodizable: 13.43 cm

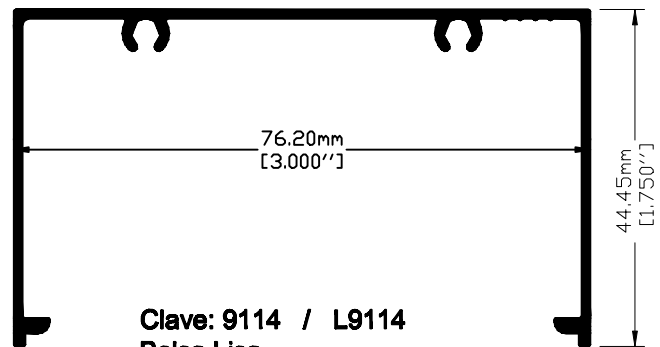

Clave: 9114 / L9114
Bolsa Lisa
Perimetro Anodizable: 37.17 cm

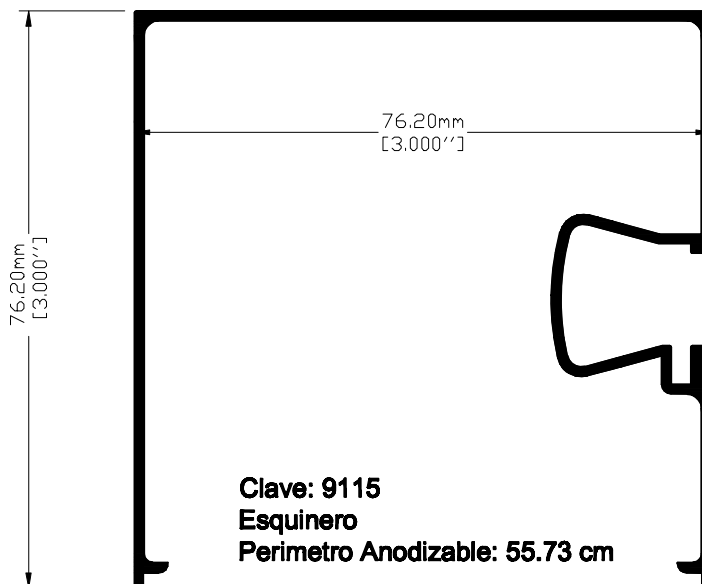

Clave: 9115
Esquinero
Perimetro Anodizable: 55.73 cm

Alubin de México

FIJO DE 3"

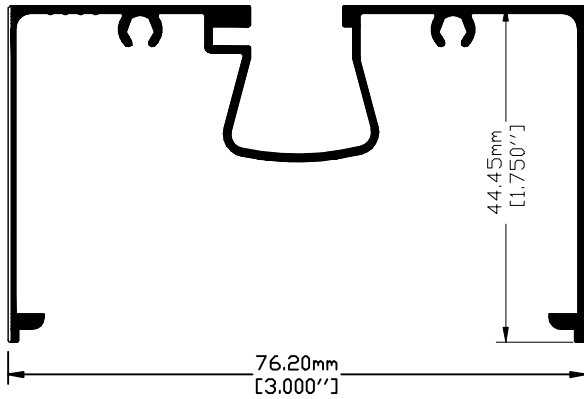

Clave: 9135 / L9135
Bolsa
Perimetro Anodizable: 46.57 cm

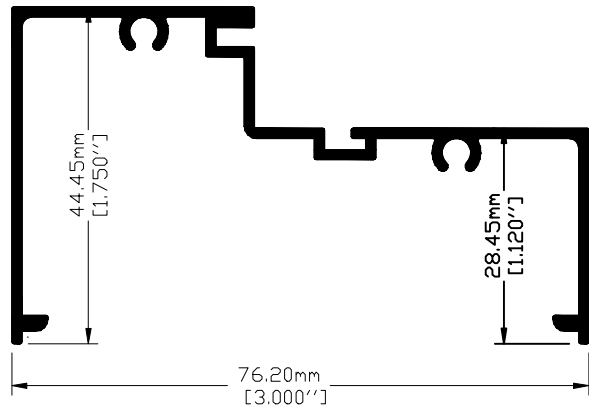

Clave: 9136 / L9136
Escalonado
Perimetro Anodizable: 39.43 cm

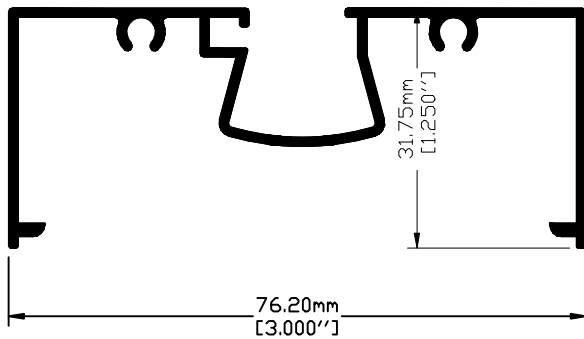

Clave: 10235
Bolsa Corta
Perimetro Anodizable: 40.86 cm

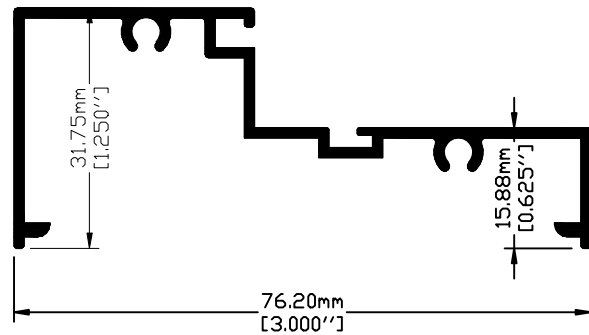

Clave: 10236
Escalonado Corto
Perimetro Anodizable: 34.62 cm

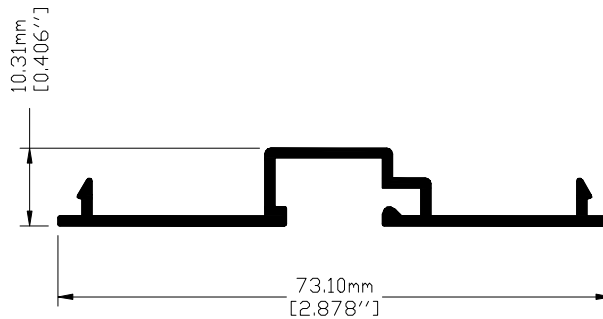

Clave: 10237
Tapa Bolsa Corta
Perimetro Anodizable: 21.72 cm

Alubin de México

FIJO DE 4"

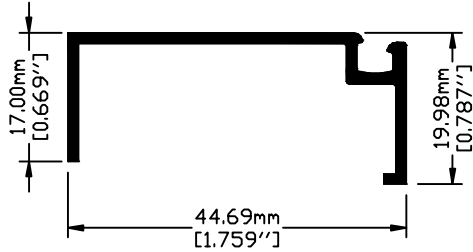

Clave: 6606
Junquillo
Perimetro Anodizable: 17.22 cm

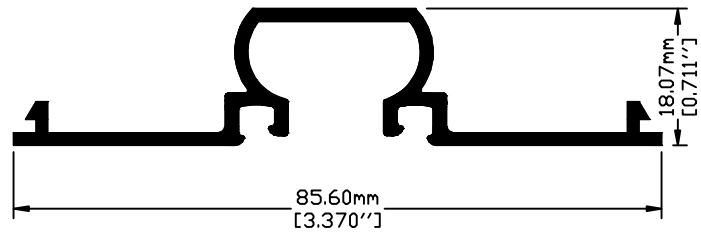

Clave: 6609
Tapa Bolsa
Perimetro Anodizable: 29.01 cm

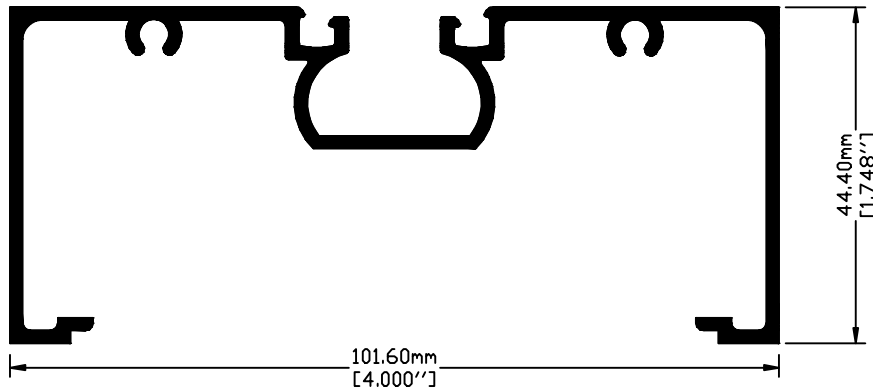

Clave: 9117
Bolsa
Perimetro Anodizable: 55.16 cm

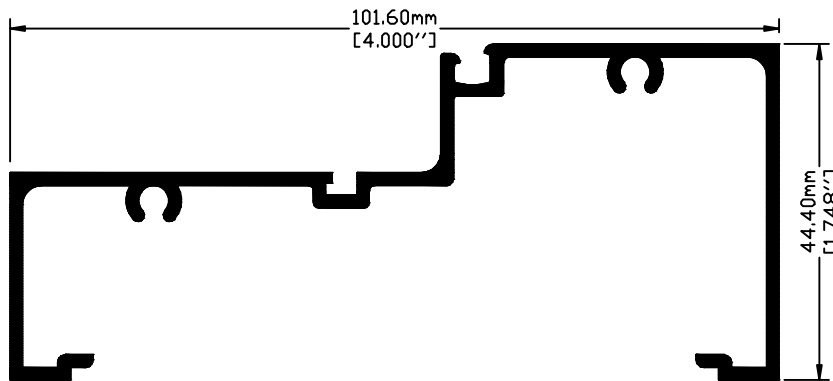

Clave: 9118
Escalonado
Perimetro Anodizable: 47.30 cm

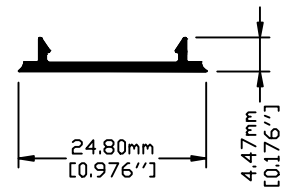

Clave: 10481
Tapa
Perimetro Anodizable: 6.35 cm

Alubin de México

CORREDIZA DE 1 1/2"

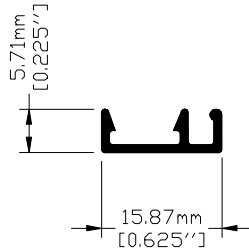

Clave: 11763
Mosquitero
Perimetro Anodizable: 6.18 cm

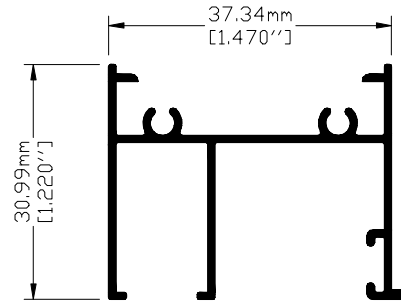

Clave: 11835
Jamba Cabezal
Perimetro Anodizable: 29.69 cm

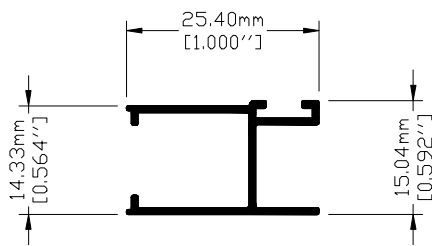

Clave: 11836
Cerco Traslapo
Perimetro Anodizable: 14.41 cm

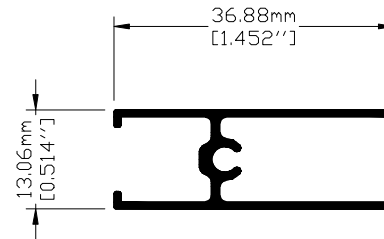

Clave: 11837
Zoco Cabezal
Perimetro Anodizable: 19.11 cm

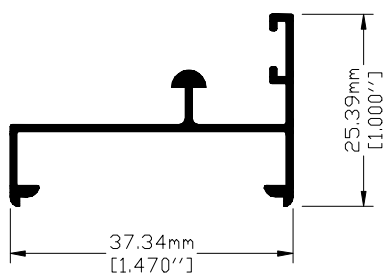

Clave: 11838
Riel
Perimetro Anodizable: 18.60 cm

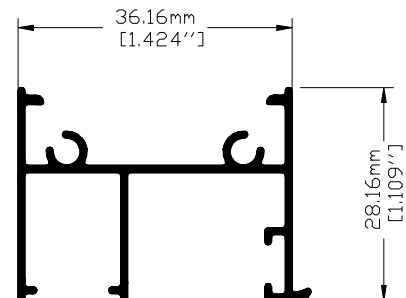

Clave: 15309
Jamba Cabezal
Perimetro Anodizable: 10.92 cm

Alubin de México

CORREDIZA DE 1 1/2"

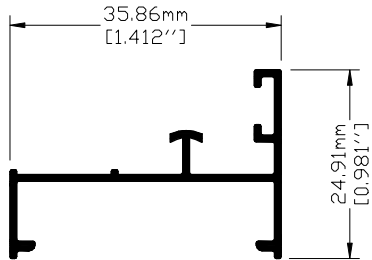

Clave: 15310
Riel
Perimetro Anodizable: 18.29 cm

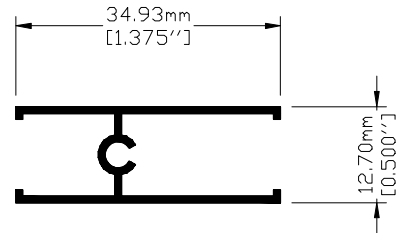

Clave: 15311
Zocio Cabezal
Perimetro Anodizable: 17.98 cm

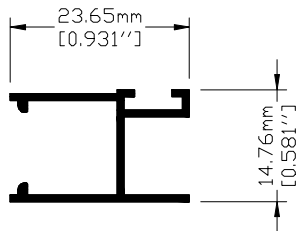

Clave: 15312
Cerco Traslape
Perimetro Anodizable: 13.85 cm

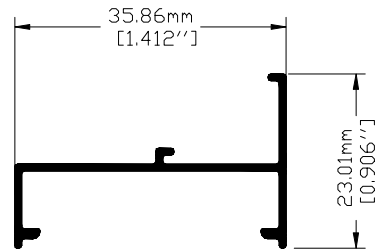

Clave: 15313
Escalonado Fijo
Perimetro Anodizable: 15.38 cm

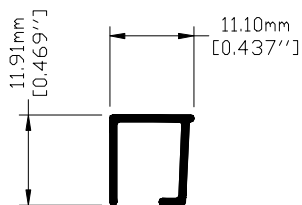

Clave: 15314
Junquillo
Perimetro Anodizable: 6.47 cm

Alubin de México

CORREDIZA DE 2"

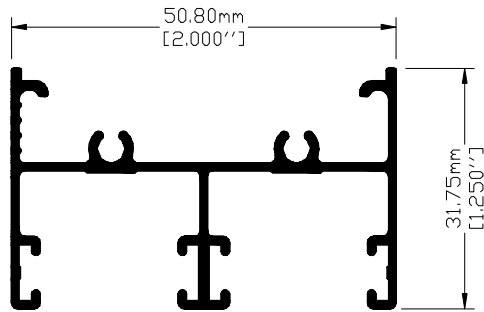

Clave: 7518 / L7518
Jamba Cabezal
Perimetro Anodizable: 36.12 cm

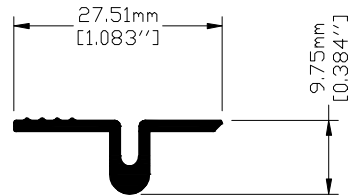

Clave: 7818
Riel Adicional
Perimetro Anodizable: 8.16 cm

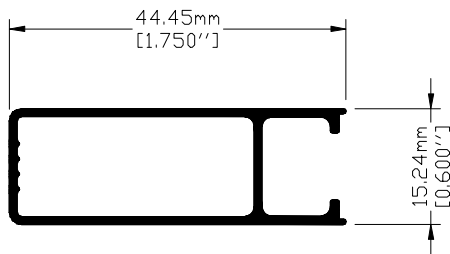

Clave: 7821 / L7821
Cerco Puerta
Perimetro Anodizable: 14.51 cm

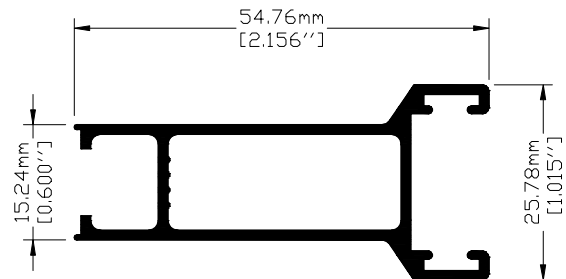

Clave: 7822
Cerco OXO
Perimetro Anodizable: 22.18 cm

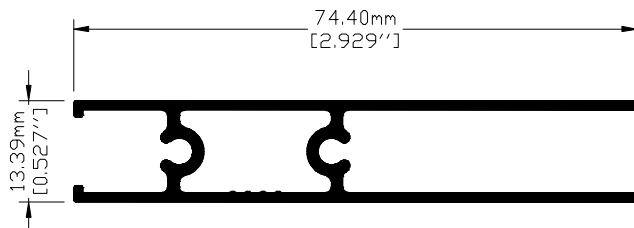

Clave: 7825 / L7825
Zoclo Puerta
Perimetro Anodizable: 29.71 cm

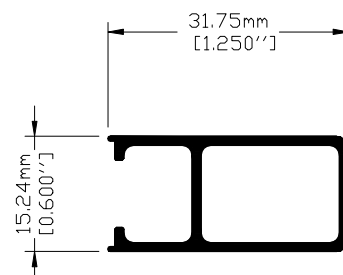

Clave: 8320
Cerco Ventana
Perimetro Anodizable: 11.97 cm

Alubin de México

CORREDIZA DE 2"

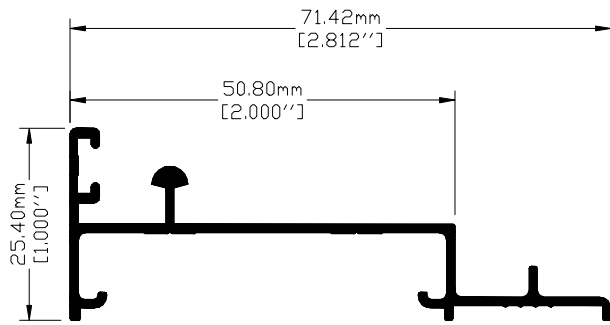

Clave: 8370 / L8370
Riel con Mosquitero
Perimetro Anodizable: 26.83 cm

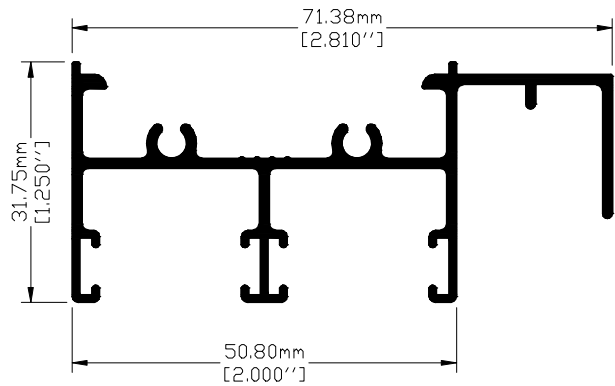

Clave: 7819 / L7819
Jamba con Mosquitero
Perimetro Anodizable: 42.85 cm

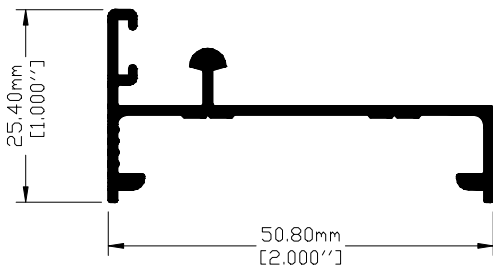

Clave: 9953 / L9953
Riel
Perimetro Anodizable: 22.09 cm

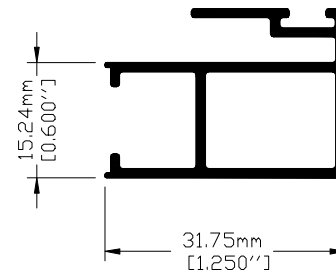

Clave: 9954 / L9954
Traslape Ventana
Perimetro Anodizable: 16.20 cm

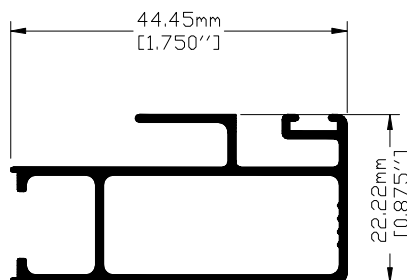

Clave: 9955 / L9955
Traslape Puerta
Perimetro Anodizable: 10.74 cm

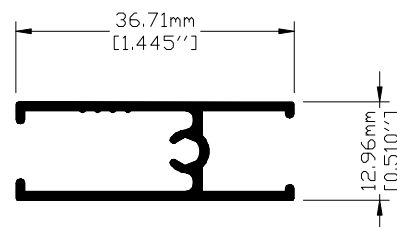

Clave: 9956 / L9956
Zoclo Cabezal
Perimetro Anodizable: 19.00 cm

Alubin de México

CORREDIZA DE 2"

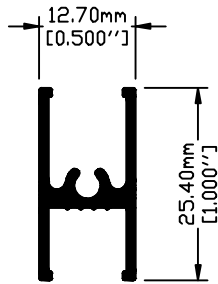

Clave: L11203
Intermedio 2"
Perimetro Anodizable: 13.54 cm

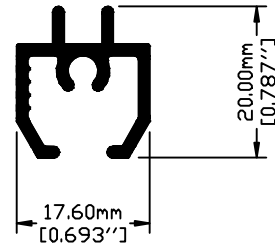

Clave: 2415
Cerco para Cuadrícula
Perimetro Anodizable: 13.56 cm

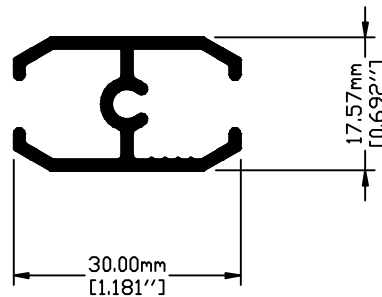

Clave: 2416
Intermedio para Cuadrícula
Perimetro Anodizable: 18.16 cm

Alubin de México

CORREDIZA DE 3"

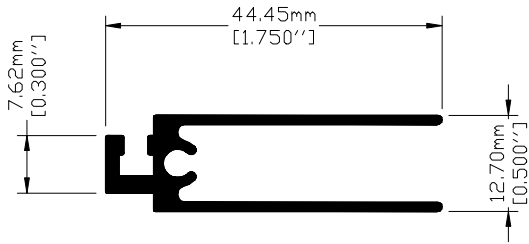

Clave: 6533
Mosquitero Horizontal
Perimetro Anodizable: 20.61 cm

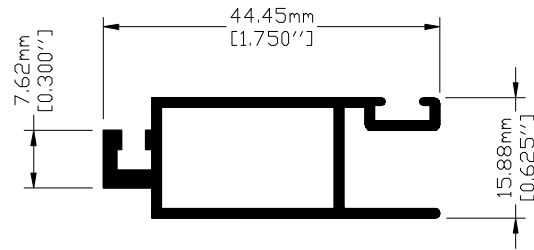

Clave: 6534
Cerco Mosquitero
Perimetro Anodizable: 17.44 cm

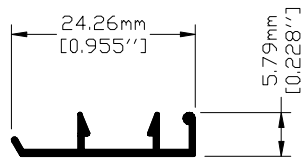

Clave: 7333
Moisquitero Economico
Perimetro Anodizable: 8.26 cm

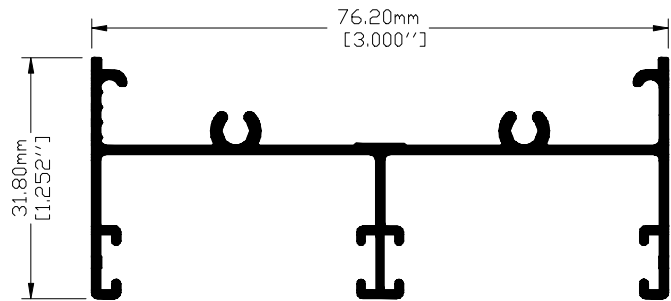

Clave: 7826 / L7826
Jamba Cabezal
Perimetro Anodizable: 41.29 cm

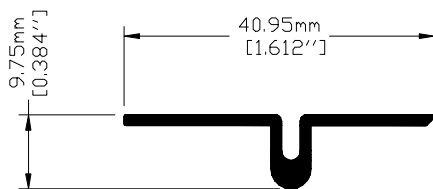

Clave: 7828
Riel Adicional
Perimetro Anodizable: 10.85 cm

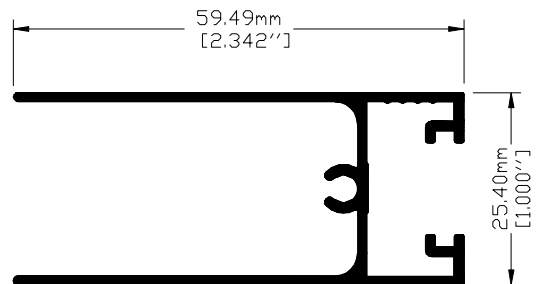

Clave: 7835 / L7835
Zoclo Ventana
Perimetro Anodizable: 34.30 cm

Alubin de México

CORREDIZA DE 3"

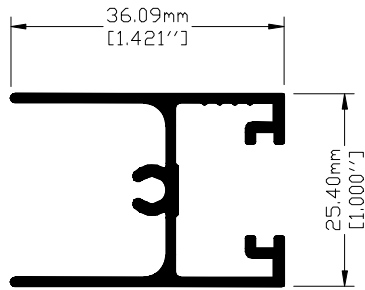

Clave: 7836 / L7836
Cabezal Ventana
 Perimetro Anodizable: 24.83 cm

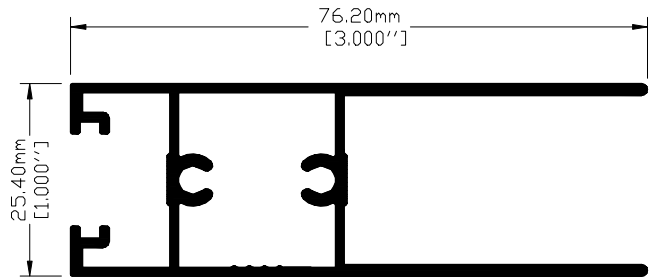

Clave: 7842 / L7842
Zoclo Puerta
 Perimetro Anodizable: 34.57 cm

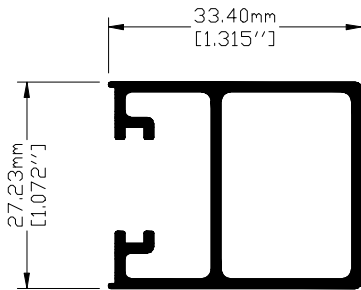

Clave: 7843
Cerco Ventana
 Perimetro Anodizable: 19.00 cm

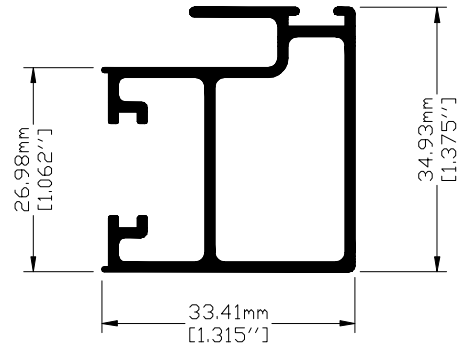

Clave: 7844
Traslape Ventana
 Perimetro Anodizable: 23.66 cm

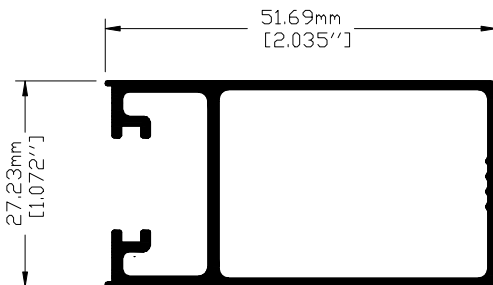

Clave: 7847 / L7847
Cerco Puerta
 Perimetro Anodizable: 22.49 cm

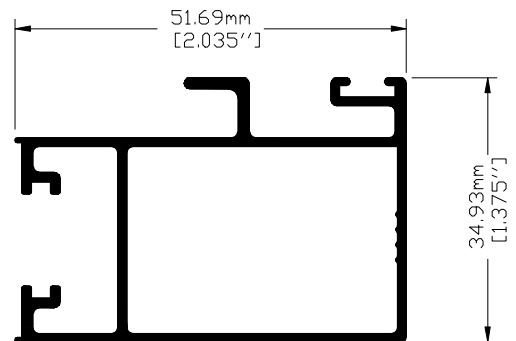

Clave: 7848 / L7848
Traslape Puerta
 Perimetro Anodizable: 26.21 cm

Alubin de México

CORREDIZA DE 3"

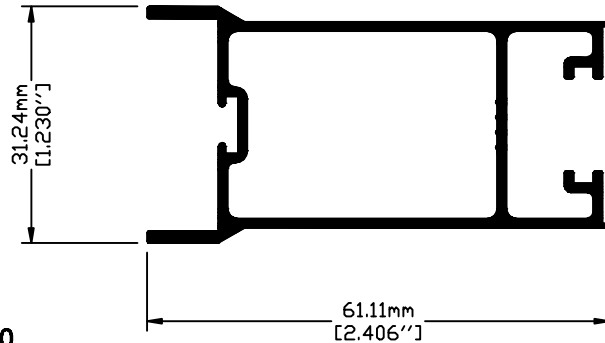

Clave: 7850 / L7850
Cerro OXXO
Perimetro Anodizable: 27.92 cm

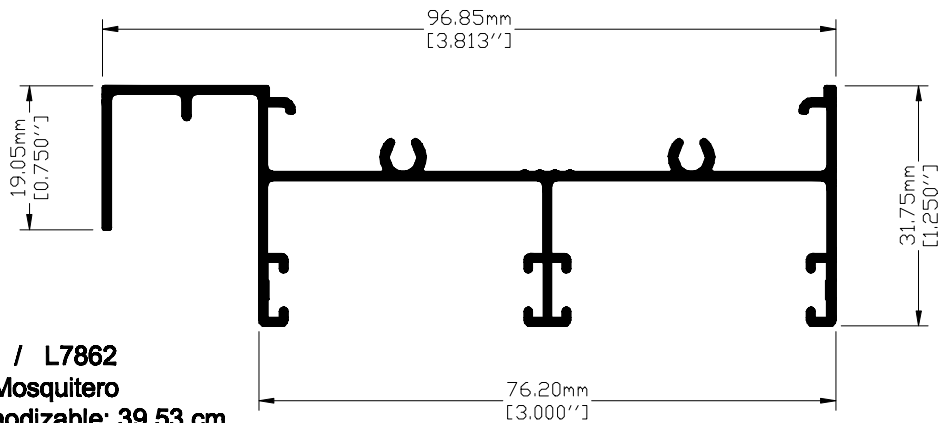

Clave: 7862 / L7862
Jamba con Mosquitero
Perimetro Anodizable: 39.53 cm

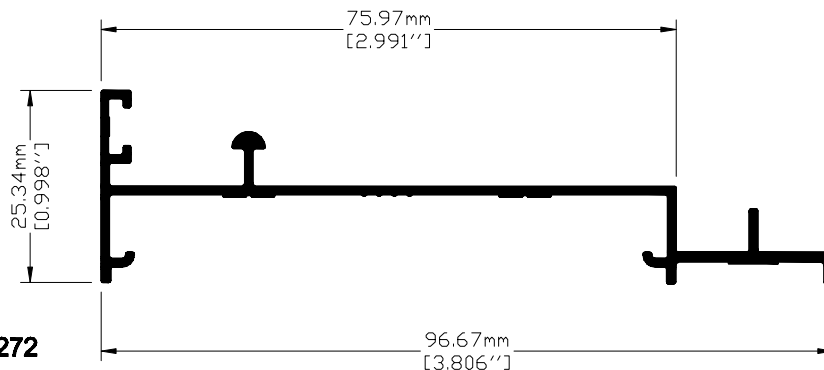

Clave: 9272 / L9272
Riel con Mosquitero
Perimetro Anodizable: 32.42 cm

Alubin de México

CORREDIZA DE 3"

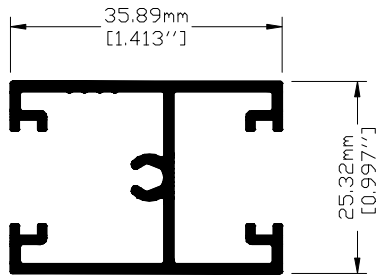

Clave: 9082 / L9082
Intermedio
Perimetro Anodizable: 28.7 cm

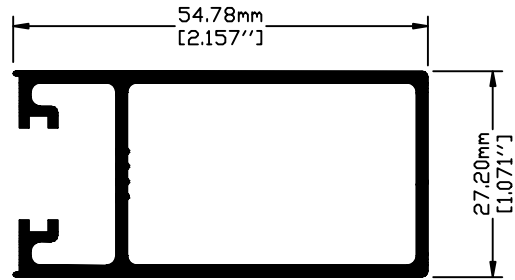

Clave: 9236 / L9236
Cerco Chapa
Perimetro Anodizable: 23.03 cm



Clave: 9957 / L9957
Riel
Perimetro Anodizable: 27.03 cm

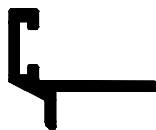

Clave: L10220
Adaptador oxo
Perimetro Anodizable: 7.67 cm

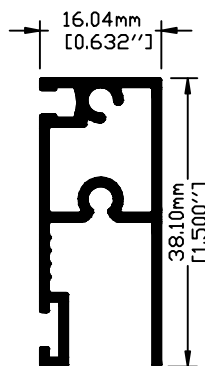

Clave: L10358
Mosquero Universal
Perimetro Anodizable: 18.03 cm

Alubin de México

PUERTA 1500

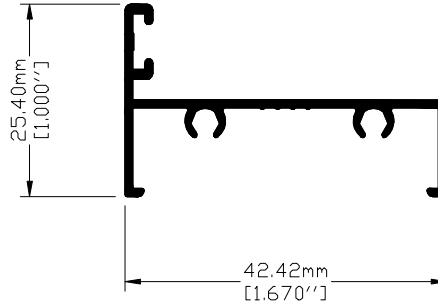

Clave: 8550 / L8550
Batiente Corta
Perimetro Anodizable: 20.56 cm

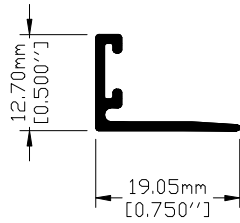

Clave: 11032
Batiente Economica
Perimetro Anodizable: 7.45 cm

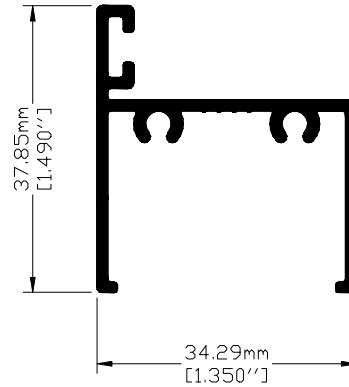

Clave: 33087
Batiente Alta
Perimetro Anodizable: 24.60 cm

Alubin de México

PUERTA 1750

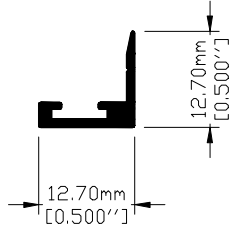

Clave: 4105
Batiente Puerta Económica
Perimetro Anodizable: 5.89 cm

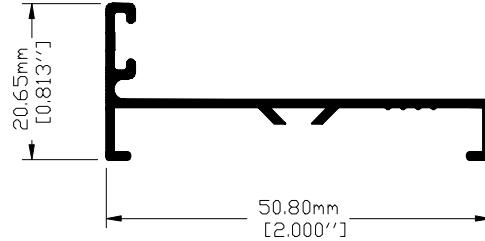

Clave: 5844 / L5844
Batiente
Perimetro Anodizable: 17.86 cm

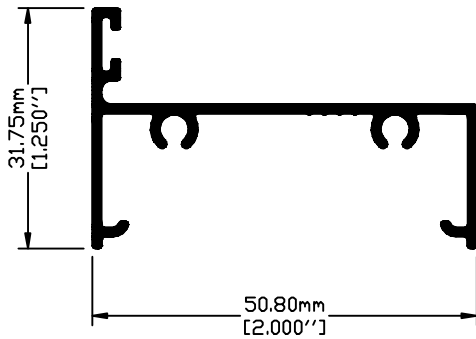

Clave: L35844
Batiente con Venas
Perimetro Anodizable: 26.24 cm

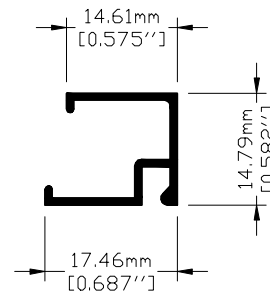

Clave: 6370
Junquillo
Perimetro Anodizable: 10.00 cm

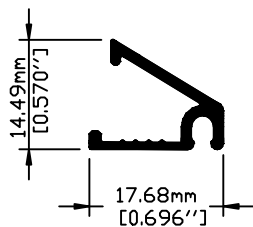

Clave: L6371
Junquillo Biselado
Perimetro Anodizable: 08.13 cm

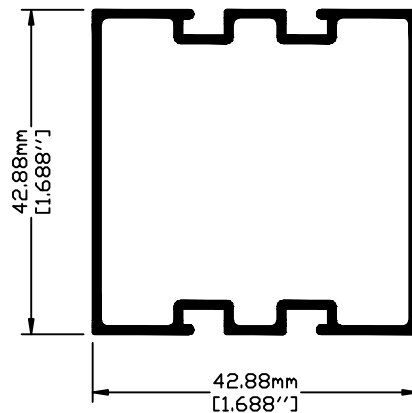

Clave: 9183 / L9183
Intermedio
Perimetro Anodizable: 20.74 cm

Alubin de México

PUERTA 1750

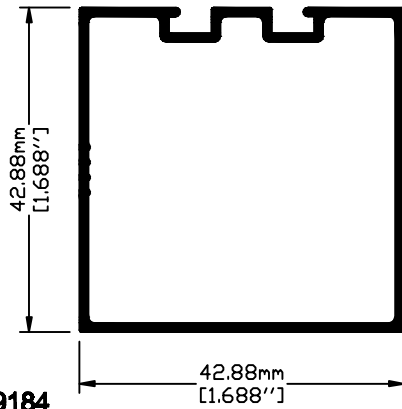

Clave: L9184
Remate
Perimetro Anodizable: 18.92 cm

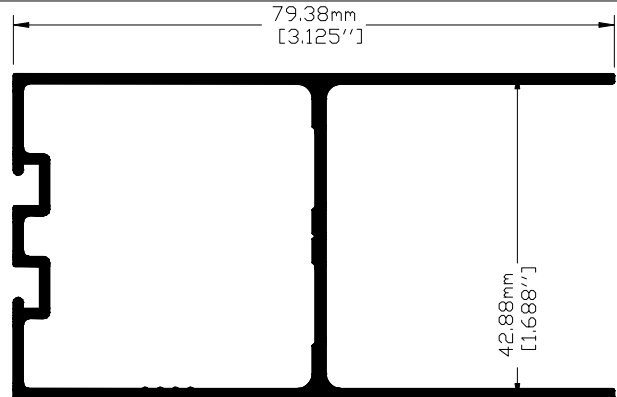

Clave: 9187 / L9187
Zoclo
Perimetro Anodizable: 33.70 cm

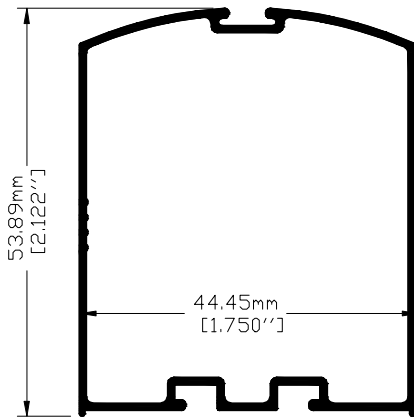

Clave: 9204 / L9204
Cerco Chapa
Perimetro Anodizable: 21.60 cm

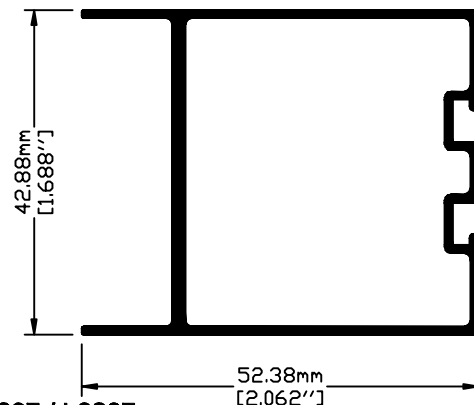

Clave: 9207 / L9207
Cabezal
Perimetro Anodizable: 23.11 cm

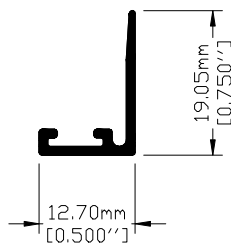

Clave: 11032
Batiente Economica
Perimetro Anodizable: 7.45 cm



Clave: 8327
Zoclo Herculite 1/2
Perimetro Anodizable: 40.67 cm

Alubin de México

PROYECCION 2"

Clave: 8936
Marco Tubular
Perimetro Anodizable: 24.44 cm

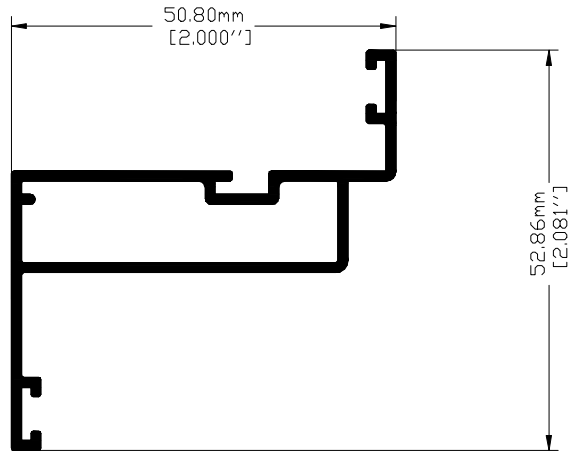

Clave: 8937
Contra Marco
Perimetro Anodizable: 31.25 cm

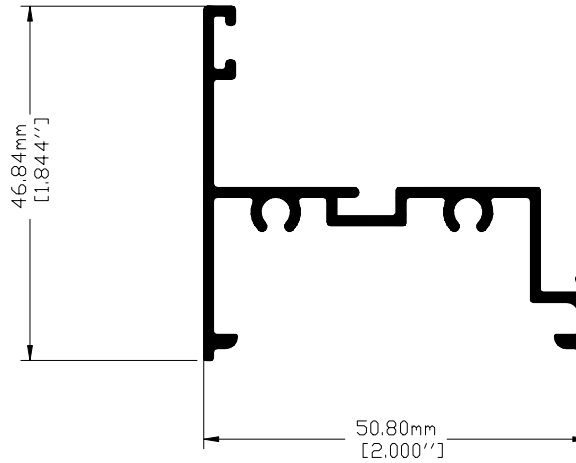

Clave: 8939
Junquillo Ventila
Perimetro Anodizable: 15.85 cm

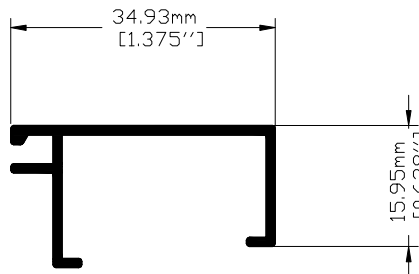

Alubin de México

VENTANA SIFÓN 3"

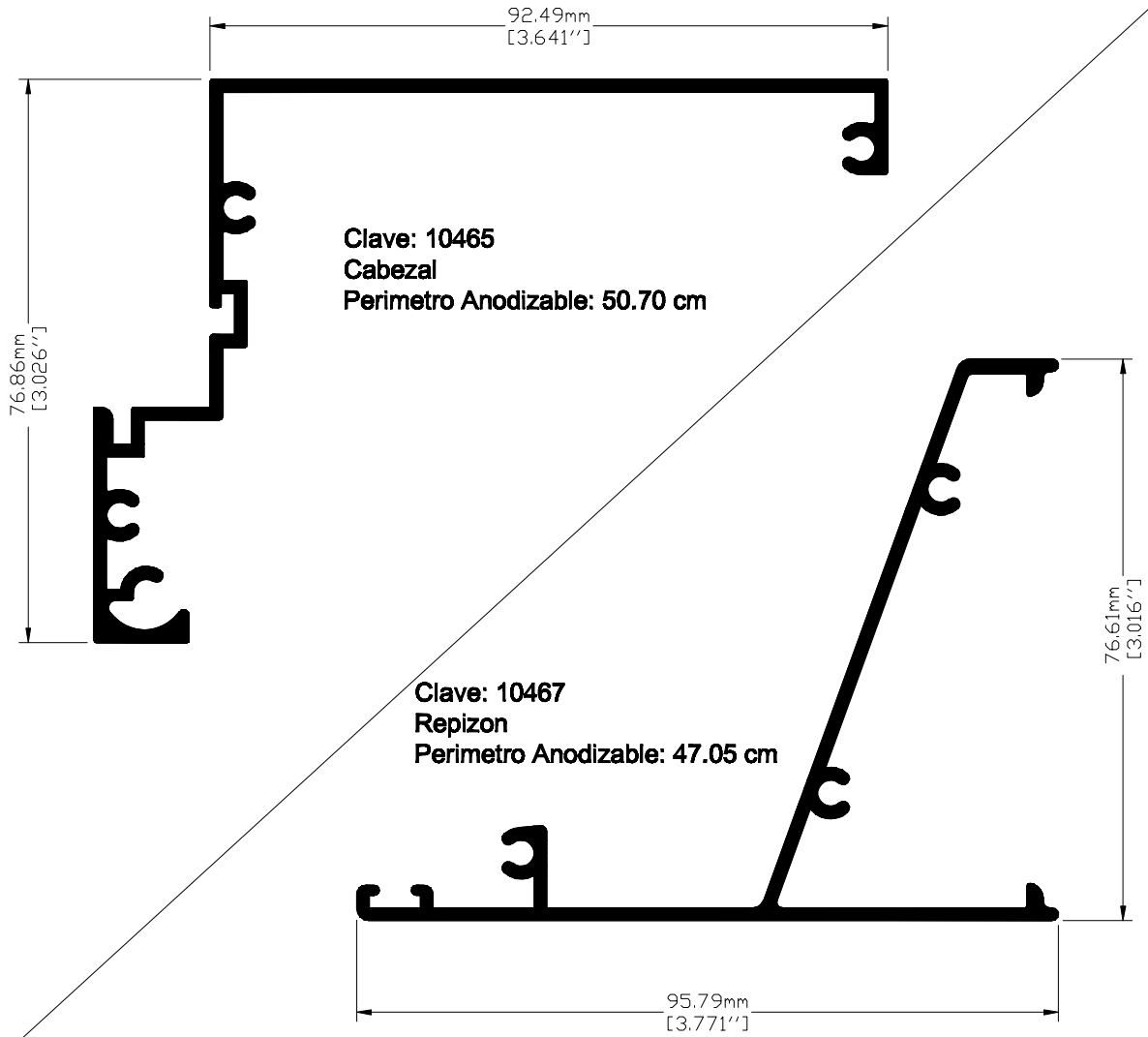

Clave: 10466
Jaladera
Perimetro Anodizable: 28.59 cm

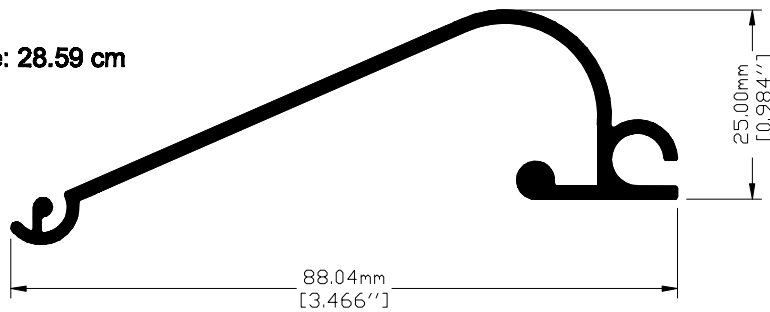

Alubin de México

BAÑOS

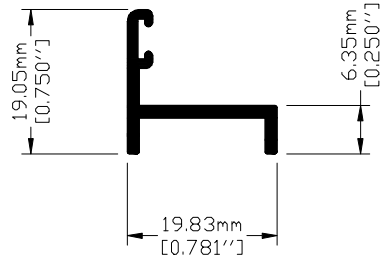

Clave: 4127
Batiente corta
Perimetro Anodizable: 96.01 cm

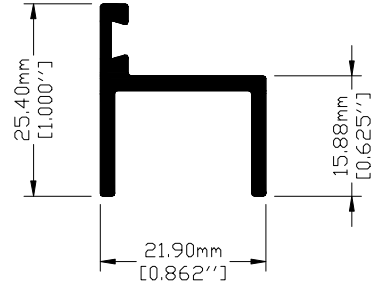

Clave: 7102
Batiente alta
Perimetro Anodizable: 12.68 cm

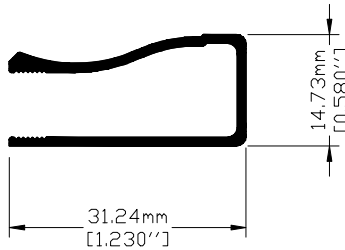

Clave: 9525
Marco Económico
Perimetro Anodizable: 15.55 cm

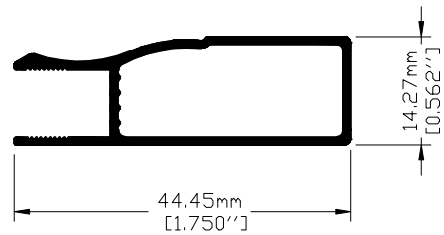

Clave: 9756 / L9756
Marco de 1 3/4"
Perimetro Anodizable: 14.39 cm

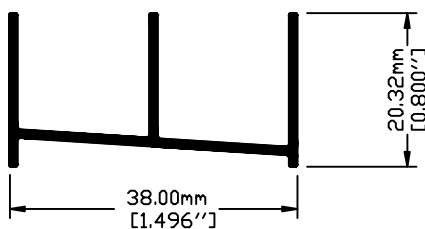

Clave: L9945
Riel inferior
Perimetro Anodizable: 18.66 cm

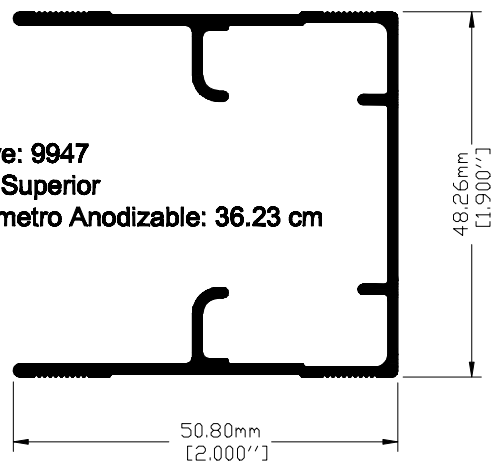

Clave: 9947
Riel Superior
Perimetro Anodizable: 36.23 cm

Alubin de México

B A Ñ O S

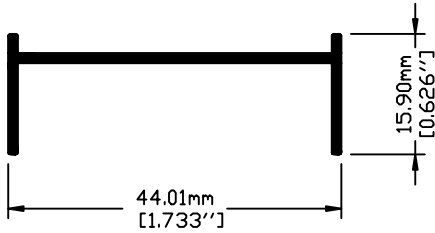

Clave: 10197
Jamba Lateral
 Perimetro Anodizable: 14.79 cm

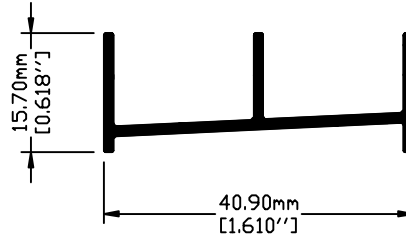

Clave: 10198
Riel Inferior
 Perimetro Anodizable: 16.32 cm

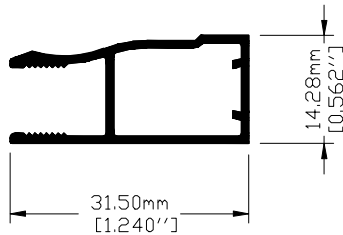

Clave: 11035
Marco de 1 1/4"
 Perimetro Anodizable: 18.18 cm

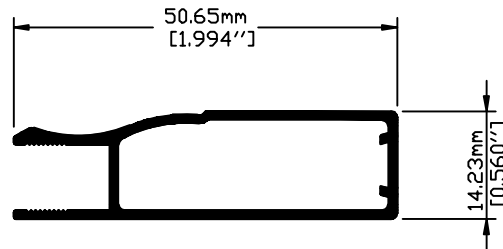

Clave: 11173
Marco 2"
 Perimetro Anodizable: 15.67 cm

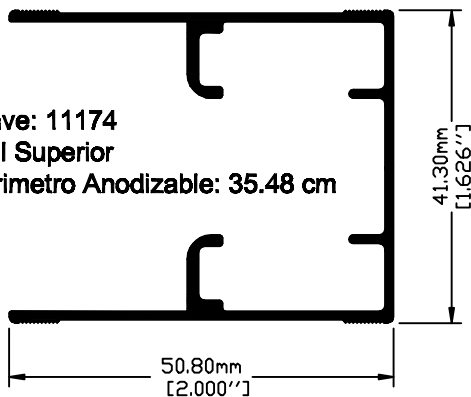

Clave: 11174
Riel Superior
 Perimetro Anodizable: 35.48 cm

Alubin de México

BAÑOS

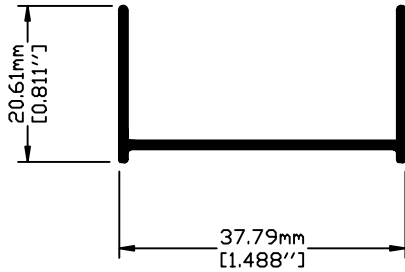

Clave: 11386
Jamba lateral
Perimetro Anodizable: 15.42 cm

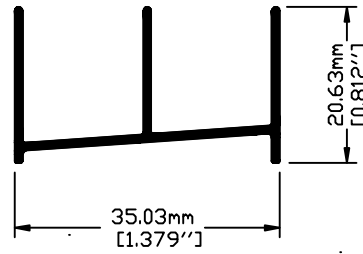

Clave: 11387
Riel Inferior
Perimetro Anodizable: 18.15 cm

Alubin de México

RECUBRIMIENTOS

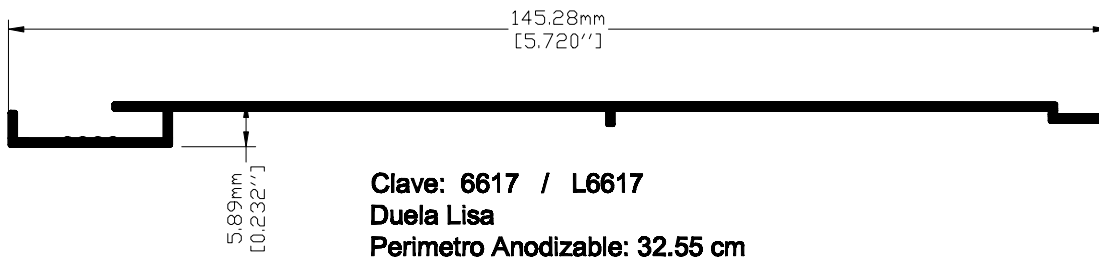

Clave: L6775
Duela Entrecalle
Perimetro Anodizable: 28.70 cm

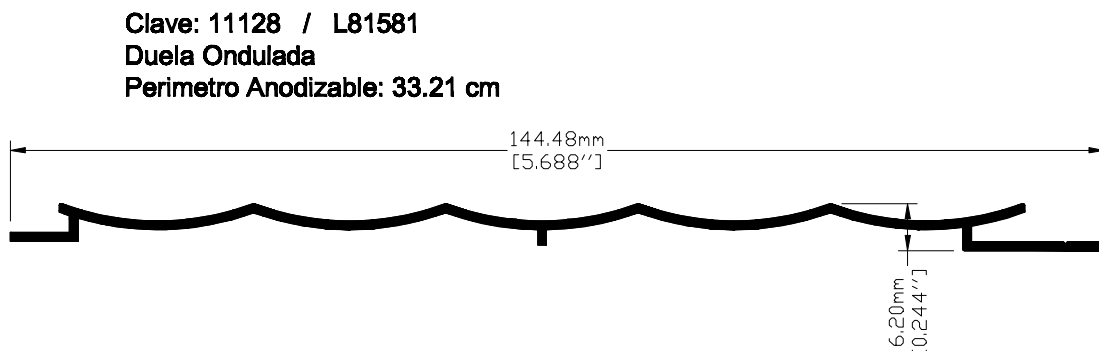
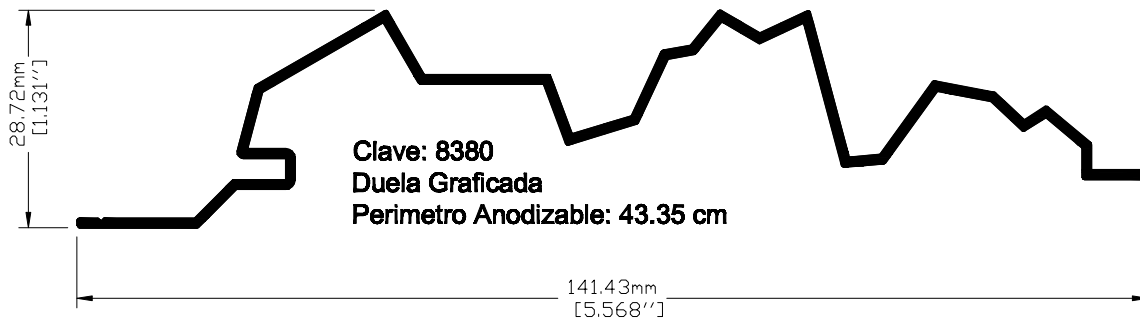
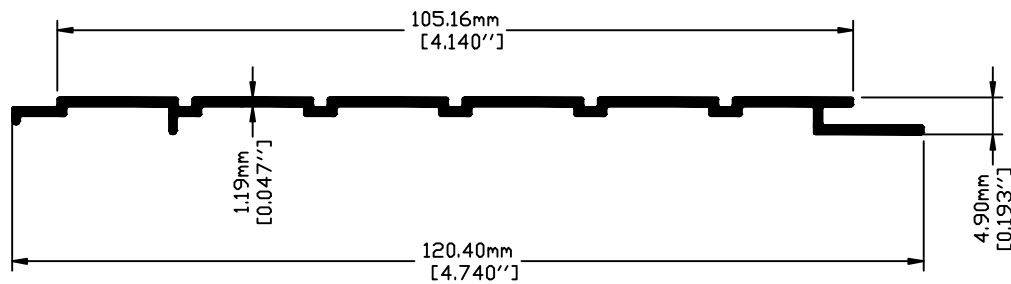

Alubin de México

PASAMANOS

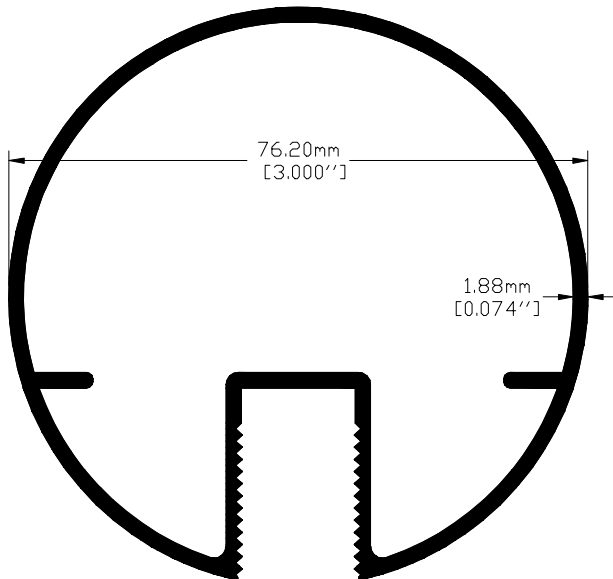

Clave: 23883
Pasamanos de 3"
Perimetro Anodizable: 30.55 cm

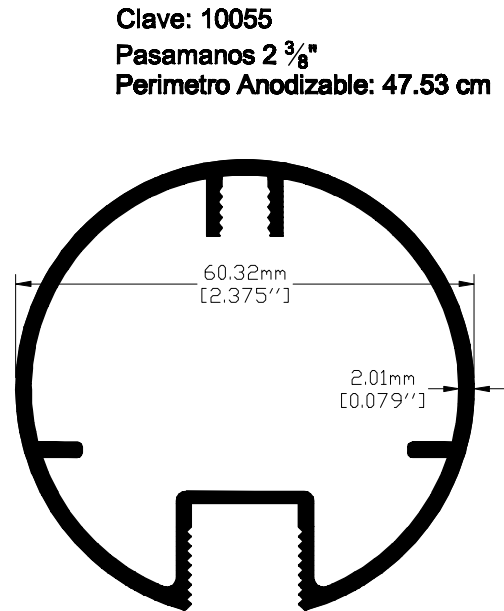

Clave: 10055
Pasamanos 2 3/8"
Perimetro Anodizable: 47.53 cm

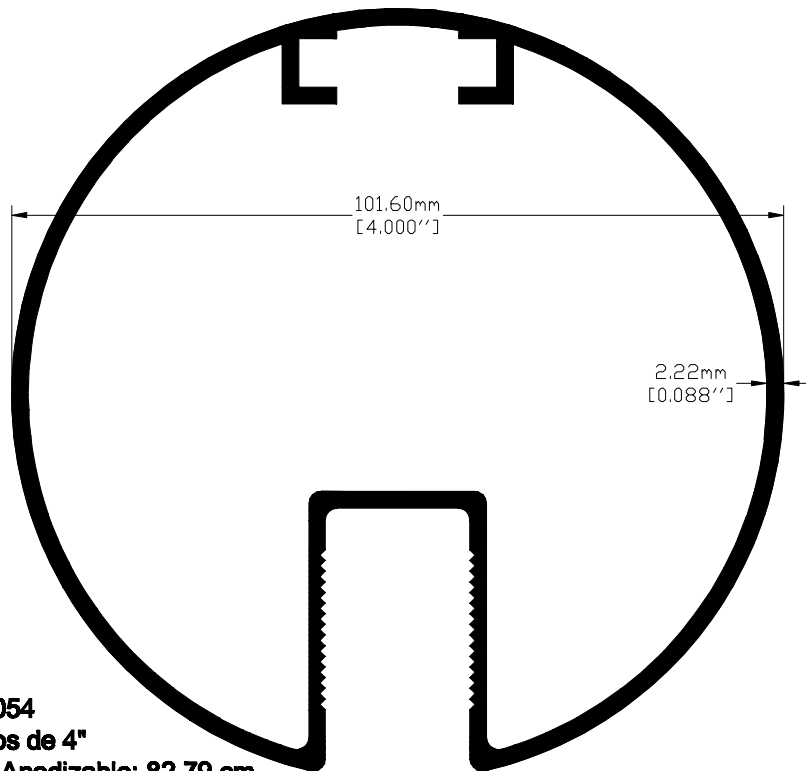

Clave: 10054
Pasamanos de 4"
Perimetro Anodizable: 82.79 cm

BARANDALES

Clave: 20293
Base para Barandal
Perimetro Anodizable: 77.70 cm

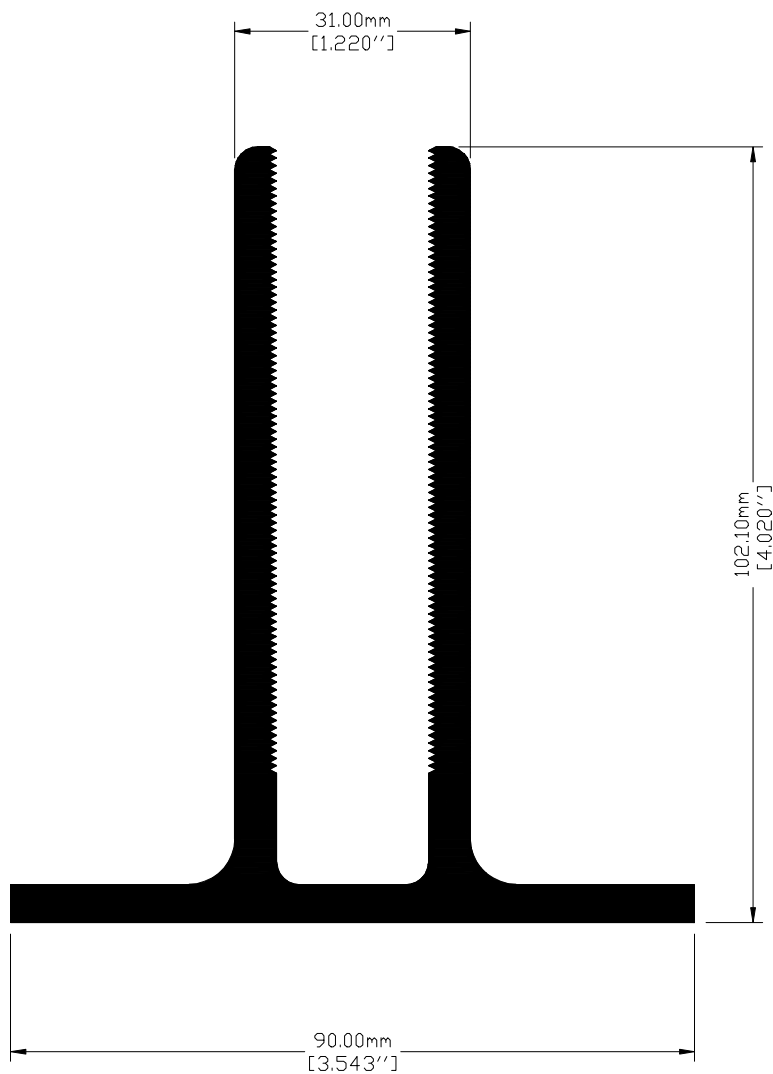

Alubin de México

LOUVERS

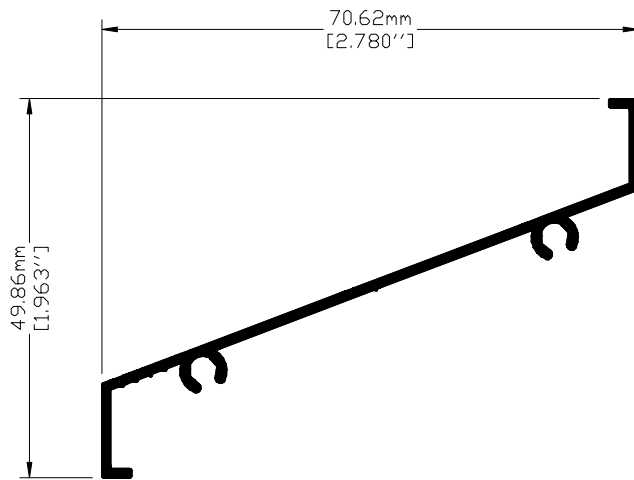

Clave: 6053 / L6053
Celocia Louver
Perimetro Anodizable: 24.13 cm

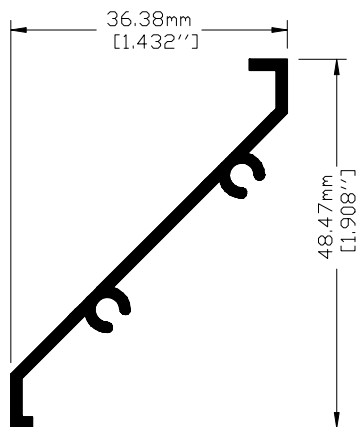

Clave: 8635
Celocia Louver
Perimetro Anodizable: 16.81 cm

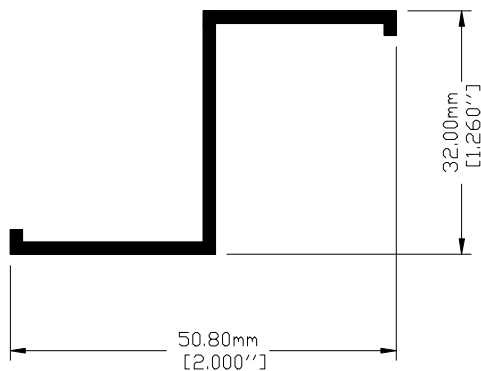

Clave: 10143
Louver 2"
Perimetro Anodizable: 17.20 cm

Alubin de México

LOUVERS

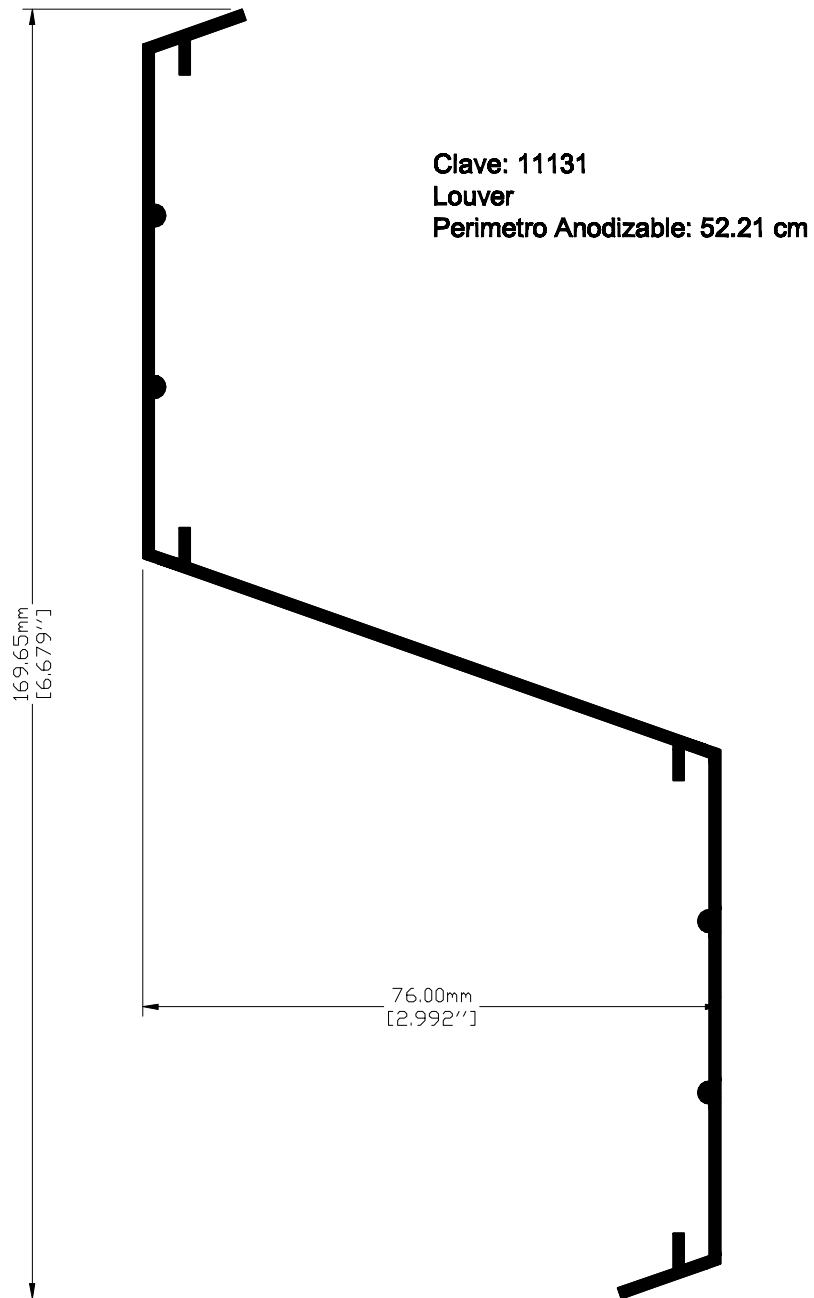

Alubin de México

O T R O S

Clave: 10056
Base para Domos
Perimetro Anodizable: 51.82 cm

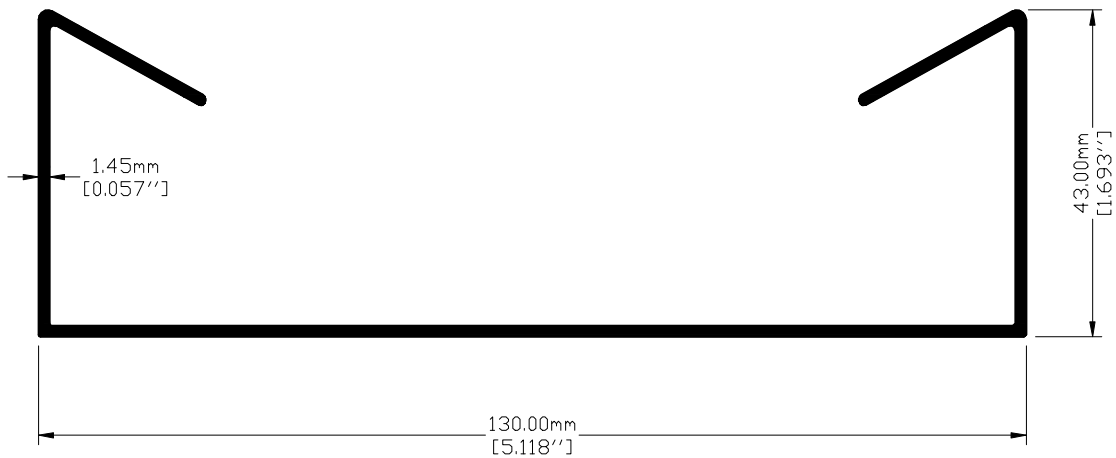

Alubin de México

PERFILES ARQUITECTÓNICOS ESTANDAR

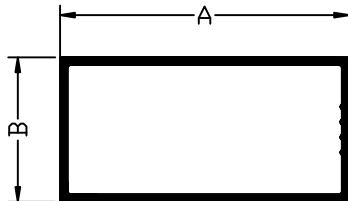

CLAVE	MEDIDAS EN PULGADAS	
	A	B
L2500	1.000	0.500
L11086	1.500	0.750
L11121	2.000	1.000
L11099	2.500	1.250
22242	3.000	1.000
L11084	3.000	1.500
L11122	3.000	1.750
11122	3.000	1.750
2520	4.000	1.750

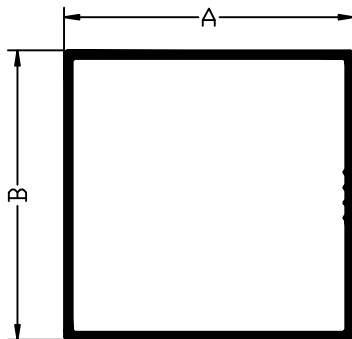

CLAVE	MEDIDAS EN PULGADAS	
	A	B
L2351	0.750	0.750
L11161	1.000	1.000
L11154	1.250	1.250
11154	1.250	1.250
L11067	1.500	1.500
L11093	1.750	1.750
11156	2.000	2.000

Alubin de México

PERFILES ARQUITECTÓNICOS ESTANDAR

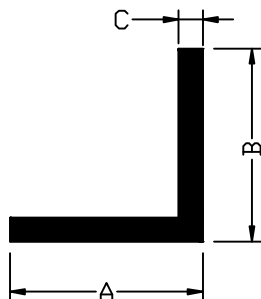

CLAVE	MEDIDAS EN PULGADAS		
	A	B	C
11031	0.500	0.500	0.050
11033	0.750	0.750	0.050
11124	1.000	1.000	0.040
1308	1.000	1.000	0.125
1320	1.500	1.500	0.062
14	1.500	1.500	0.125
1314	1.500	1.500	0.187
1329	2.000	2.000	0.187

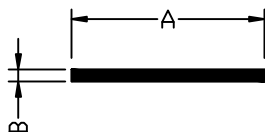

CLAVE	MEDIDAS EN PULGADAS	
	A	B
15001	0.500	0.062
15003	0.750	0.062
1202	1.000	0.062

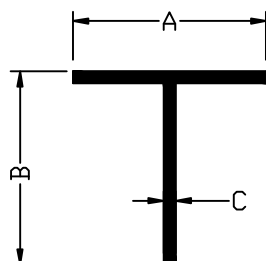

CLAVE	MEDIDAS EN PULGADAS		
	A	B	C
1613	1.000	1.000	0.035

Alubin de México

LINEA NACIONAL



**Dirección: Calle 2 sur No.120
Parque Industrial Toluca 2000, Toluca**

C. P. 50200 Edo. de Mex.

Tel: (01 722) 262 15 00

Fax: (01 722) 262 15 09

01 800 288 02 00

Dirección E. : www.alubin.com.mx

E. Mail: ventas@alubin.com.mx

**Realizo: Ing. Martín Davila Davila
Reviso: Ing. Juventino H. Hernández Ángeles**